



High Bay Light

Security
Reliability

Energy saving
Smart control



Patent product

AHBL100/150/200W



High Bay Light

Application places

GTL LIGHTING (SHEN ZHEN) CO.,LTD.



Factory



Warehouse



High Ceiling



Public Area

<http://www.gtlighting.com/>

High Bay Light

GTL LIGHTING (SHEN ZHEN) CO.,LTD.

The main characteristics

Safe



Reliability



Energy saving



Smart control



<http://www.gtlighting.com/>

High Bay Light

Product series

GTL LIGHTING (SHEN ZHEN) CO.,LTD.

AHBL 100/150/200W	EHBL 100/150/200W	HBL 100/150/200/240W
		
<p>AHBL series is cost-competitive. It keeps the element of HBL and EHBL,like water wave circular lens of self-cleaning function. No flickering, low THD, 4/6KV SPD protection and with respirator.It's a new design on thermal fixture too, which make AHBL reliable also reduce the overall cost. It creates great buying experience for more and more customers.</p>	<p>EHBL series answers the increasing request for smart lighting. It adopts built-in auxiliary power supply and integrated the sensor inside fixture, which solve the complicate wiring problem between DALI/SENSOR and input cable. This improves the performance and reduces the total cost. EHBL leaves great space for other advanced control module too, to help improve the whole system efficiency to new level.</p>	<p>HBL is the pioneer in the design of water-wave circular lens in this industry. The optical loss is only 3%. Circular lens design provides great convinience for customized change on parameters and keeps same perfect effects. More than 200,000pcs are sold worldwide each year. Our customers are benefit from this high performance and high reliable product.</p>

price

- Workshop
- Warehouse
- Airport, station, stadium
- Other industrial and commercial buildings

<http://www.gttlighting.com/>

High Bay Light

Product summary

GTL LIGHTING (SHEN ZHEN) CO.,LTD.



Specs

- * 100/150/200W
- * 4000K/5000W/5700K
- * 13000-26000lm
- * **130lm/W**
- * On/Off (0-10V)
- * CRI >80
- * No flicker
- * SDCM <5
- * **Surge 4KV/6KV**
- * 50,000 hrs @ Ta35°C
- * IP65, Ik08
- * Chain / Surface mount

- * CE/CB/ETL
- * 5years warranty

Very short payback time

Traditional HID 400W

AHBL200W

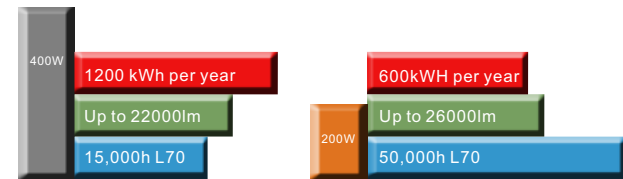

Fit for different applications

- * Multiple lumen output
- * Multiple mounting method
- * Optional reflector
- * IP66
- * Die-casting housing, Ik08

5 years warranty



Power	100W	150W	200W
Size(mm)	295*152	345*155	385*156
Lumen(lm)	13000lm	19500lm	26000lm
EFF (lm/w)	130lm/W		
Beam Angle	60°/90°/120°		



<http://www.gtlighting.com/>

High Bay Light

GTL LIGHTING (SHEN ZHEN) CO.,LTD.

Product model

AHBL
100W

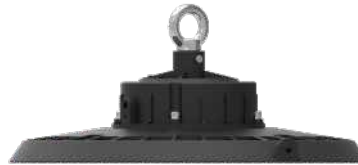

AHBL
150W

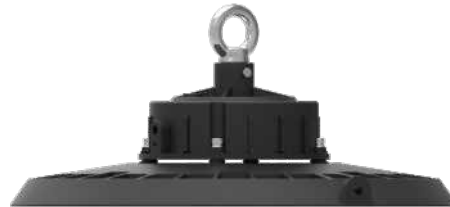

AHBL
200W



<http://www.gtlighting.com/>

High Bay Light

Specifications

GTL LIGHTING (SHEN ZHEN) CO.,LTD.

	100W	150W	200W
Lumen (lm)	13000lm	19500lm	26000lm
Efficiency	130lm/W		
CCT	4000K/5000K/5700K		
CRI	>80		
SDCM	<5		
Beam Angle	60°/90°/120°		
Power Factor	>0.95		
THD	<10%		
Surge	DM 4KV CM6 KV		
Ripple Current	<10%		
Dimensions	φ295X152mm	φ345X155mm	φ385X156mm
Weight	2.2kg	2.8kg	3.2kg
Materials	ADC12		
Mounting method	Chain / Surface mount		
Working environment	-30°C~50°C		
IK & IP	IK08/IP66		
Lumen Maintenance	L70 50,000 hrs@ 35°C		

<http://www.gtlighting.com/>

High Bay Light

Safe/Reliability

GTL LIGHTING (SHEN ZHEN) CO.,LTD.

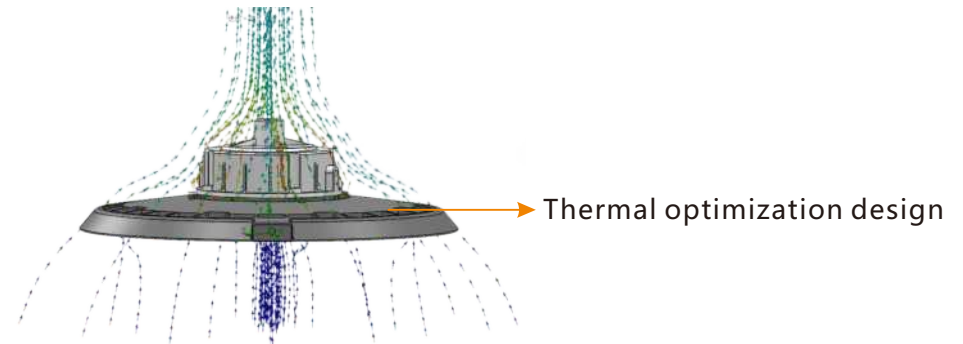
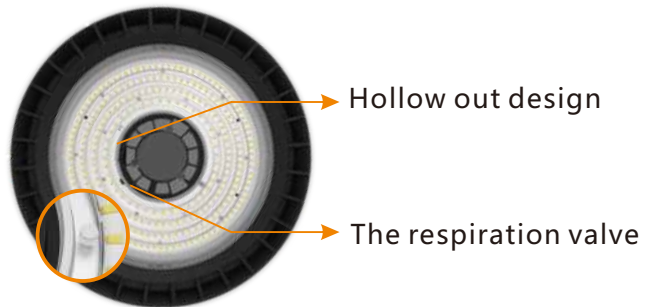
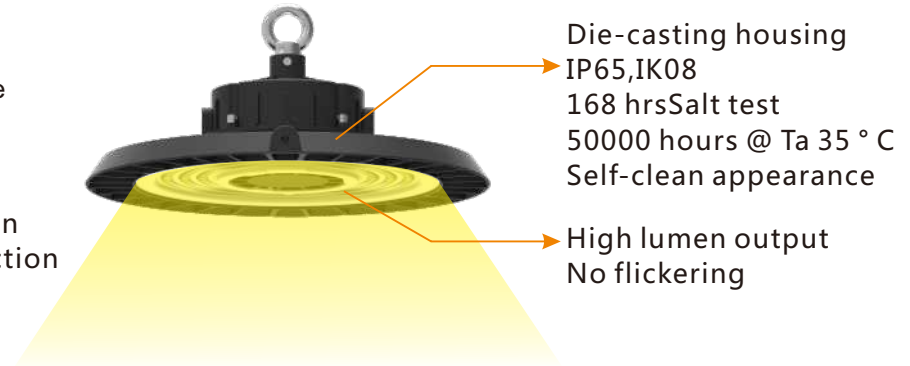
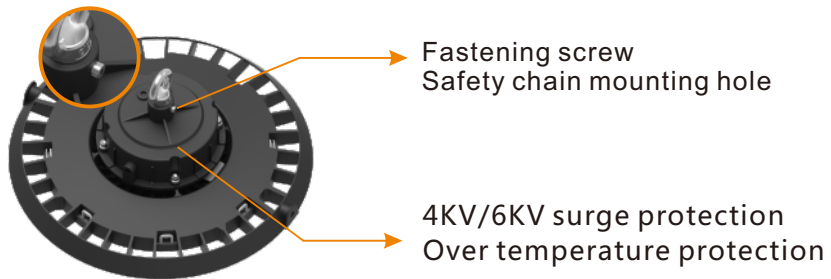

<http://www.gtlighting.com/>

Traditional HID 400W Highbay

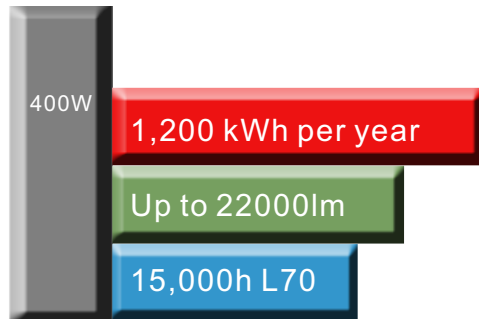

AHBL 200W



5 years total cost:

	Energy	Cost
400W HID highbay	6000kWh	900USD
AHBL 200W	3000kWh	450USD
Saving	50%	450USD

Estimations: 3000 hrs per year, 0.15 USD per kwh. Buying cost of 400W HID = 77USD , Buying cost of Simplitz AHBL 200W <100USD. Disregarding the cost of changing lamps.

<http://www.gtlighting.com/>

High Bay Light

Configuration table

GTL LIGHTING (SHEN ZHEN) CO.,LTD.

Configuration

Product name	Product category	Power	CRI	CCT	Distribution	Control	SPD
AHBL	High bay	80*/100W	>70	3000/ 4000K	30°*/60°	ON/OFF	No
		120*/150W	>80	5000/ 5700K	90°	0-10V/PWM	
		200/240W*	>90	6500K	120°		

Able to be customized, and please contact SALES directly

<http://www.gtlighting.com/>

High Bay Light

GTL LIGHTING (SHEN ZHEN) CO.,LTD.

Customization Possibility

Customizable table

	Current	Possibility	Certification Available	Note
Power	100/150/200W	75/120/175W	Yes	
Efficiency	130lmW	160lmW	Yes	
CCT	4000/5000K/5700K	3000K/6500K	Yes	The luminous flux will change due to CCT, and the price will increase by a certain percentage due to the number of led and the minimum order quantity
Beam Angle	60°/90°/120°	30°	No	New tooling is required
Control	on/off, 0-10V	DALI	No	The appearance of the product will be different
Voltage	100-277V	200-480V	Yes	

<http://www.gtlighting.com/>

High Bay Light

GTL LIGHTING (SHEN ZHEN) CO.,LTD.

Model description

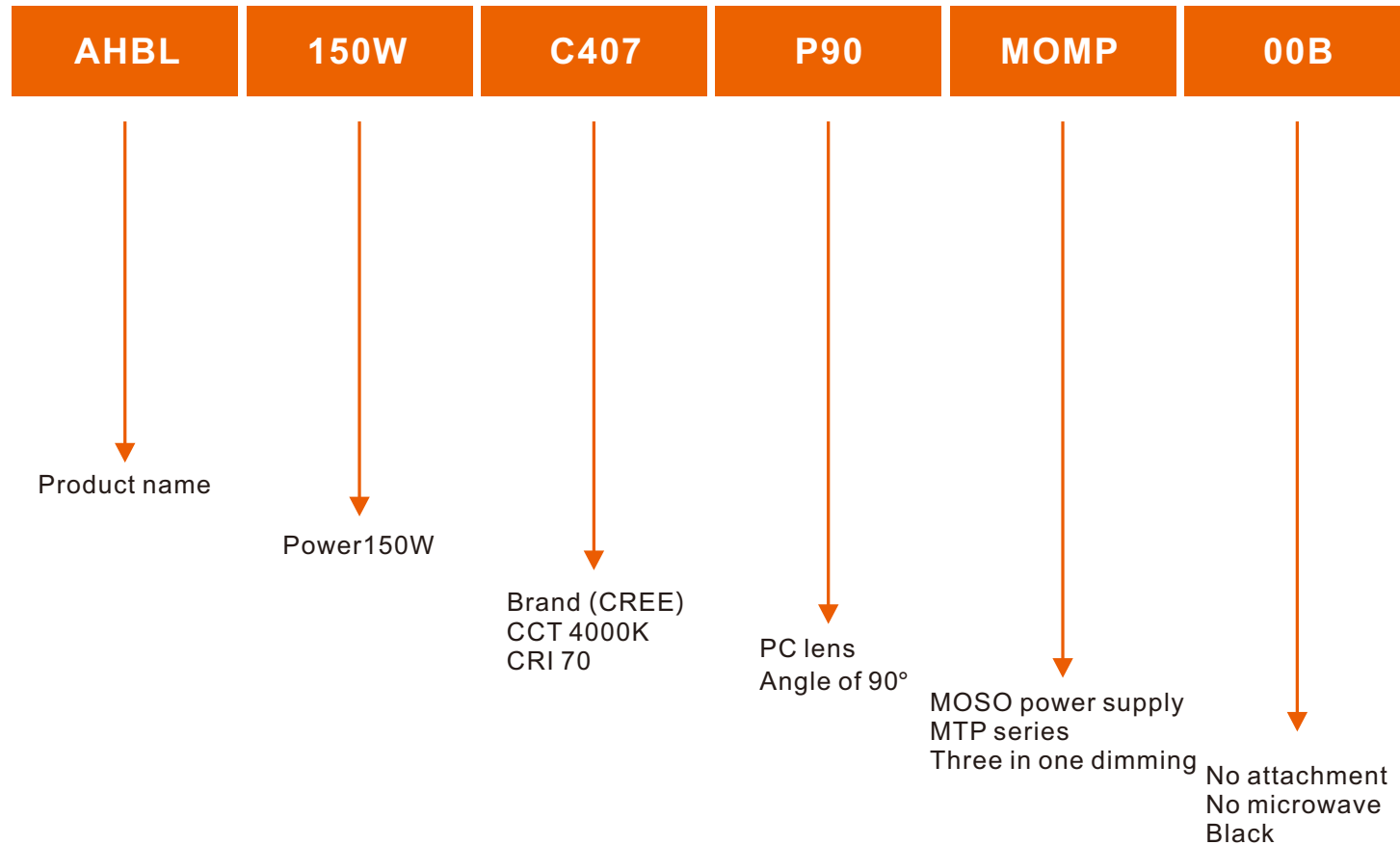

<http://www.gtlighting.com/>

High Bay Light

Installation Guide

GTL LIGHTING (SHEN ZHEN) CO., LTD.

1- Chain mount

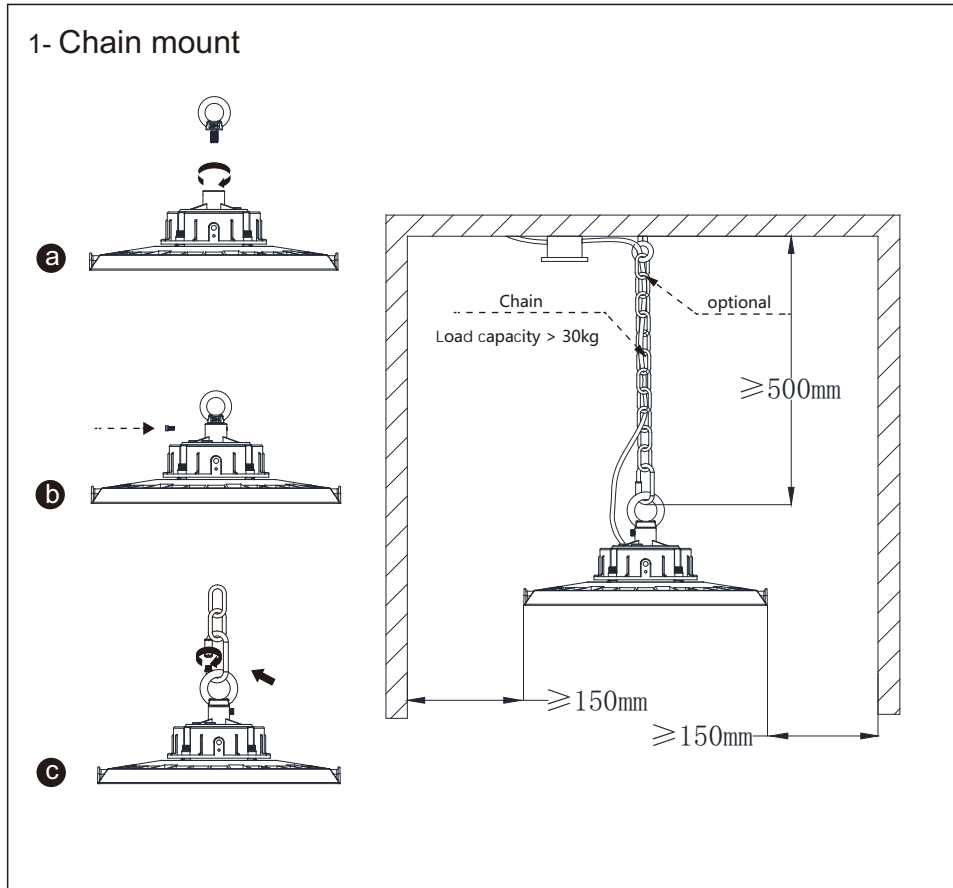

2-Surface mount

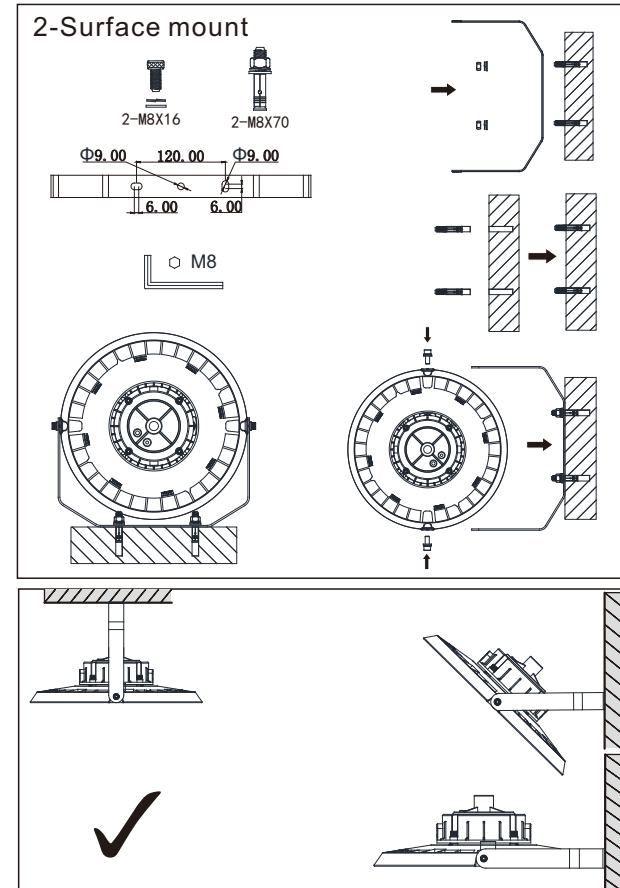

<http://www.gtlighting.com/>

High Bay Light

Container volume calculation

GTL LIGHTING (SHEN ZHEN) CO.,LTD.

Unit : mm

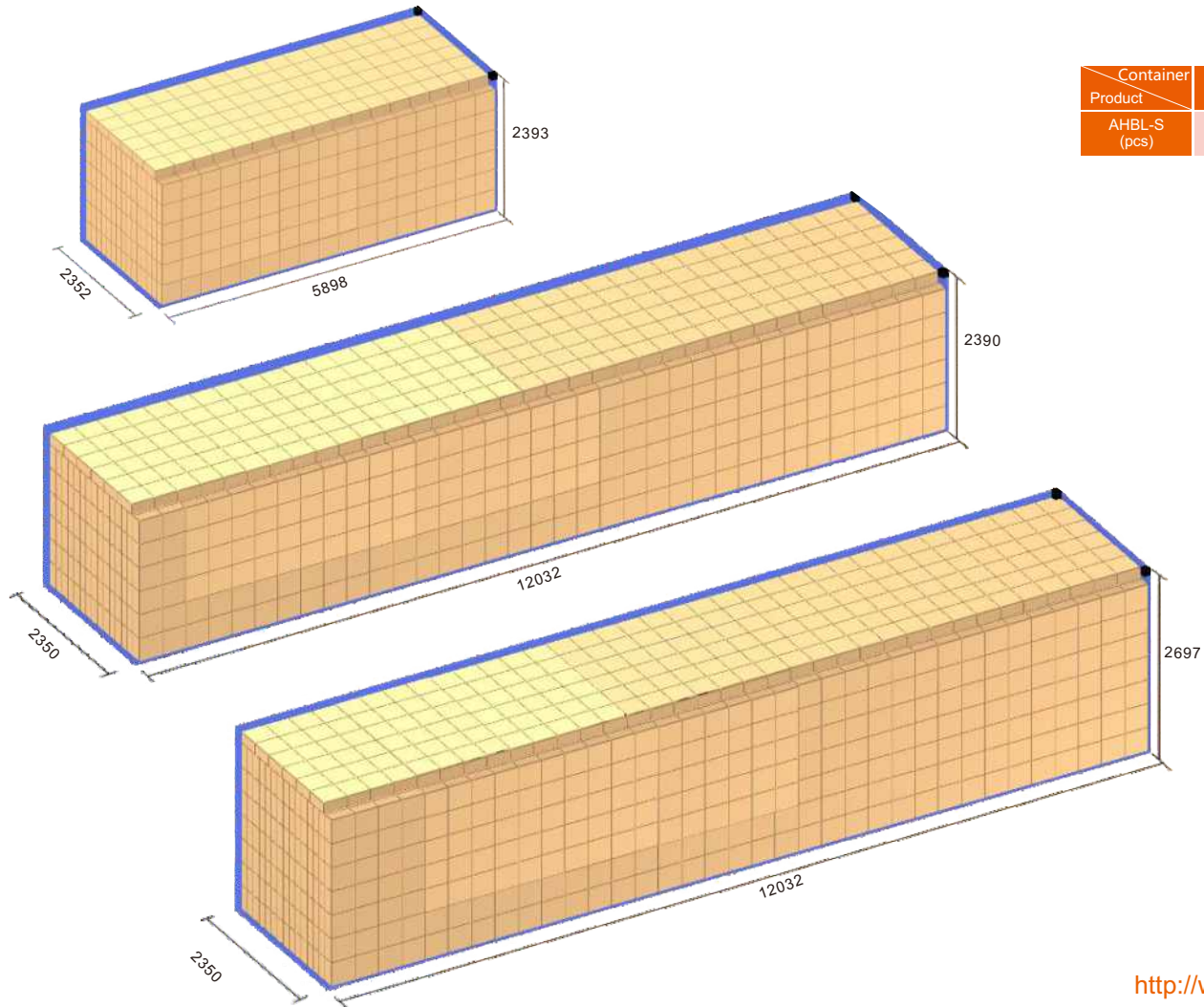
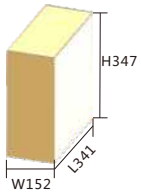

Container Product	20GP	40GP	40HC
AHBL-S (pcs)	1632	3360	3885

<http://www.gttlighting.com/>

High Bay Light

GTL LIGHTING (SHEN ZHEN) CO.,LTD.

Container volume calculation

Unit : mm

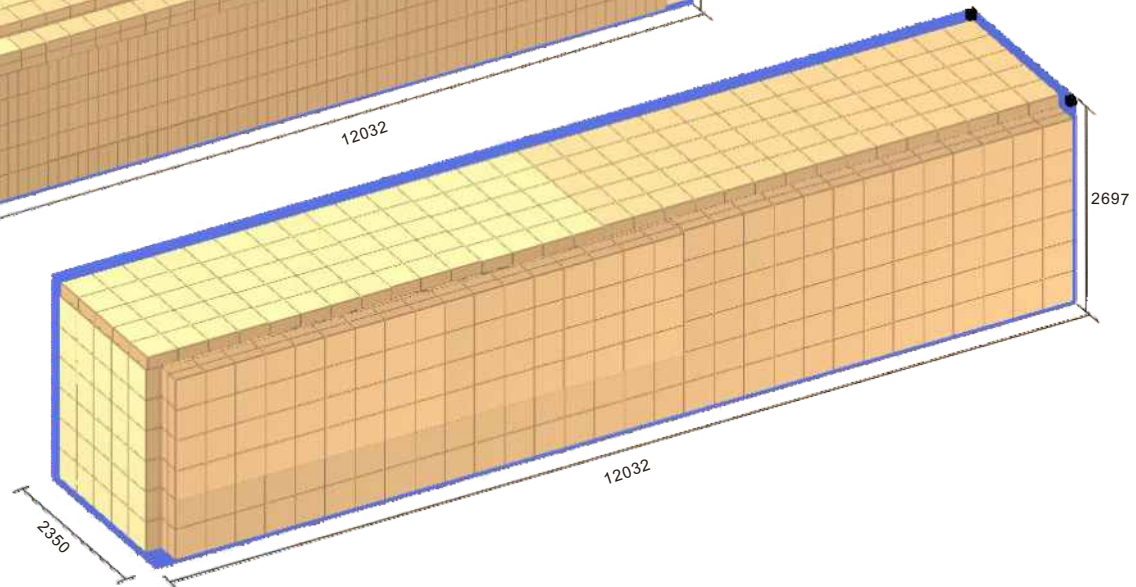
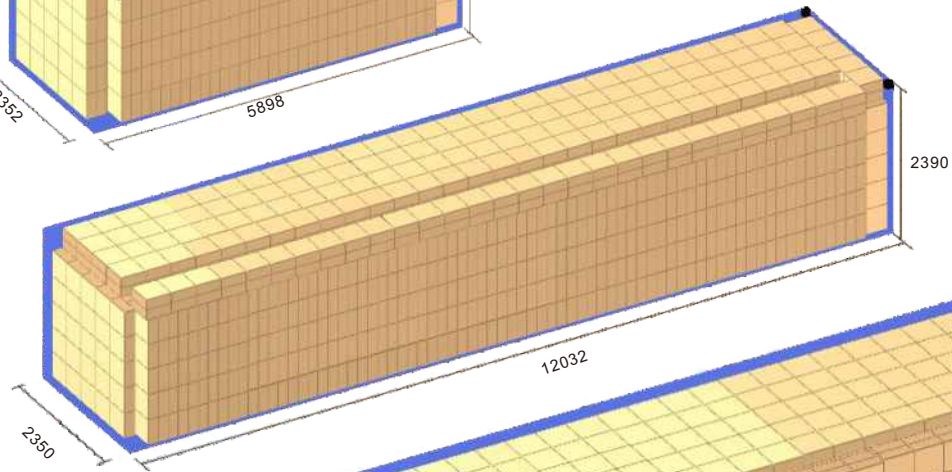
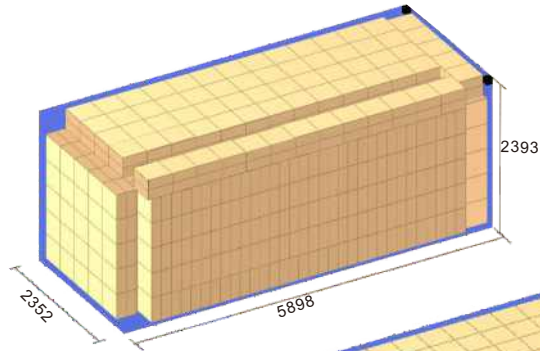
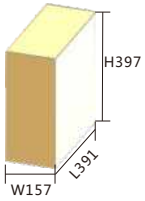

Container Product	20GP	40GP	40HC
AHBL-M (pcs)	1200	2495	2790

<http://www.gttlighting.com/>

High Bay Light

GTL LIGHTING (SHEN ZHEN) CO.,LTD.

Container volume calculation

Unit : mm

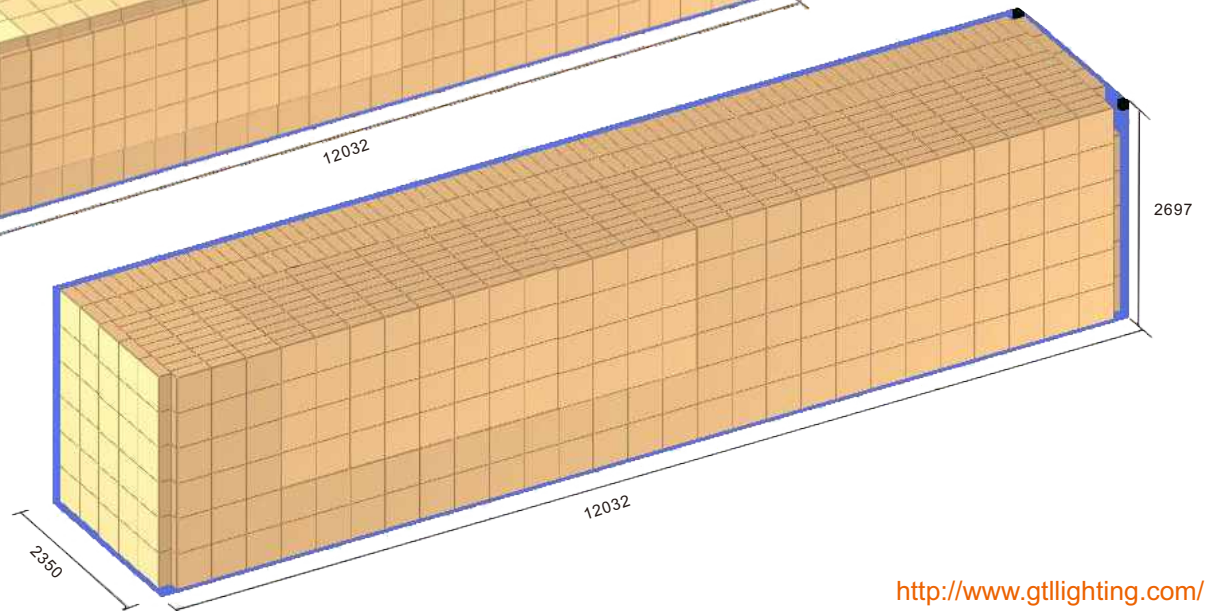
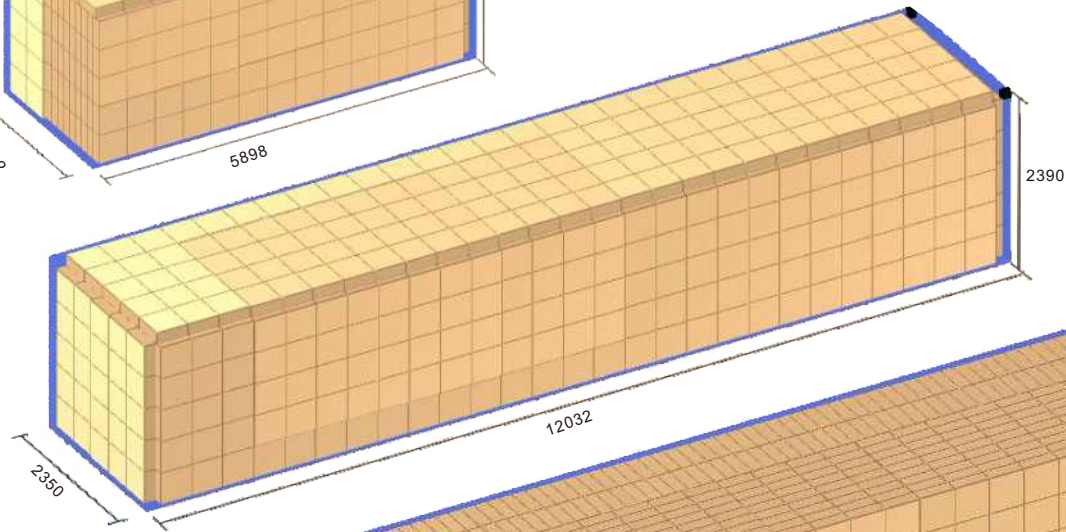
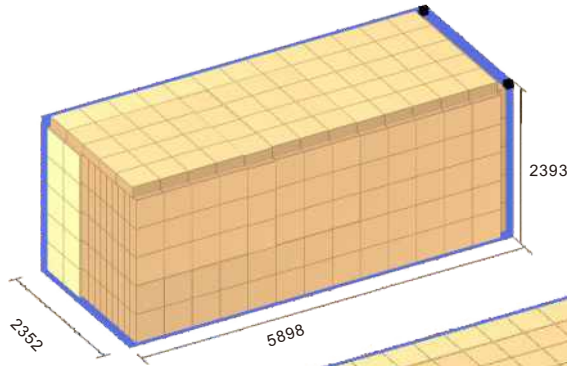
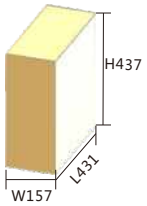

Container Product	20GP	40GP	40HC
AHBL-L (pcs)	1035	2140	2405

<http://www.gtlighting.com/>

High Bay Light

Container volume calculation

GTL LIGHTING (SHEN ZHEN) CO.,LTD.

Unit : mm

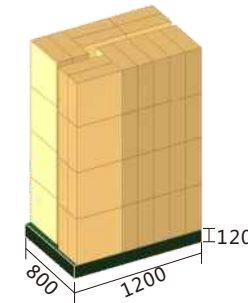
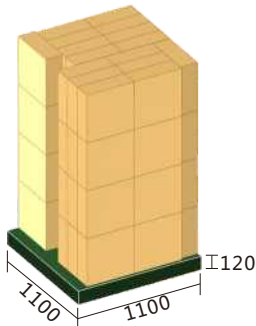
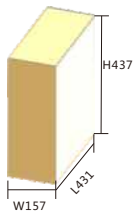
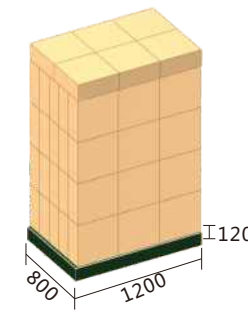
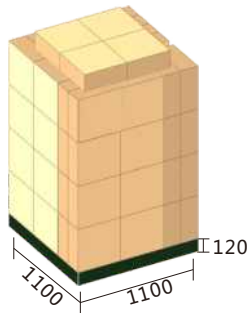
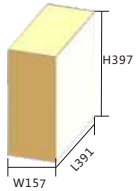
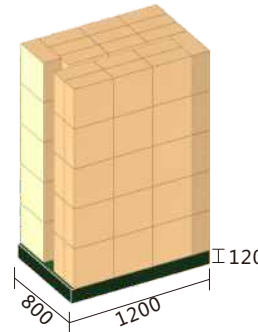
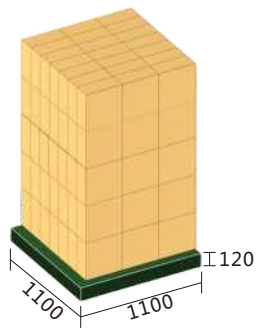
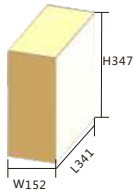

AHBL-S	Pallets		Container		
	Pallets(pcs)	pcs product/pallets	20GP	40GP	40HC
	1100*1100*120	105	10	20	20
1200*800*120	85	11	24	24	

AHBL-M	Pallets		Container		
	Pallets(pcs)	pcs product/pallets	20GP	40GP	40HC
	1100*1100*120	80	10	20	20
1200*800*120	66	11	24	24	

AHBL-L	Pallets		Container		
	Pallets(pcs)	pcs product/pallets	20GP	40GP	40HC
	1100*1100*120	64	10	20	20
1200*800*120	52	11	24	24	

<http://www.gttlighting.com/>

It's always a good choice

It's easy to find us
You can contact us in the following ways or leave us a message.
+86 755-23245019

GTL LIGHTING(SHEN ZHEN)CO.,LTD.

Address: zone A, floor 9, building 1, no. 28 cuijing road,
longtian street, pingshan new district, shenzhen city
Website: www.gtlighting.com